

CLEANING AND LUBRICATION

Clean as needed with mild soap and lukewarm water. Any common household lubricant is acceptable.

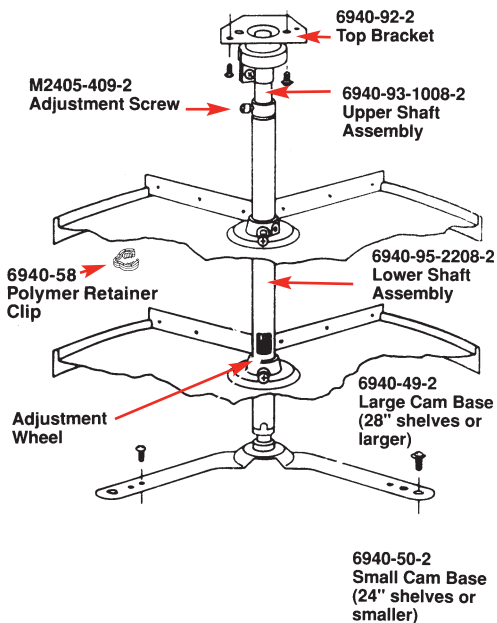

OTHER PRODUCTS

We offer a full line of cabinet organizers which compliment this system. For more information, contact your distributor or our customer service specialist on our toll-free number, 800-626-1126.

REV-A-LOCK

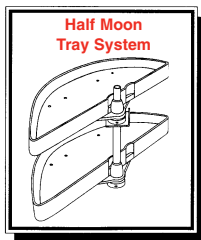
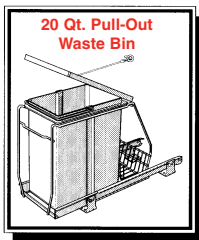
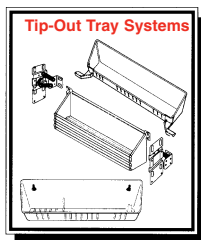
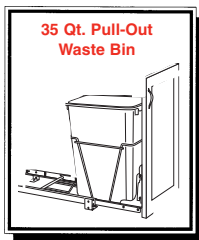
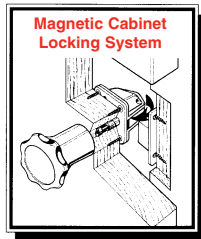

P.O. Box 99585 • 2409 Plantside Drive
Jeffersontown, Kentucky 40299
800 626-1126 • 502-499-5835 • Fax: 502-491-2215
www.rev-a-shelf.com

Congratulations!
Your cabinet contains the
finest revolving storage
system available.



PIE-CUT CABINET STORAGE ORGANIZER MODEL 6940

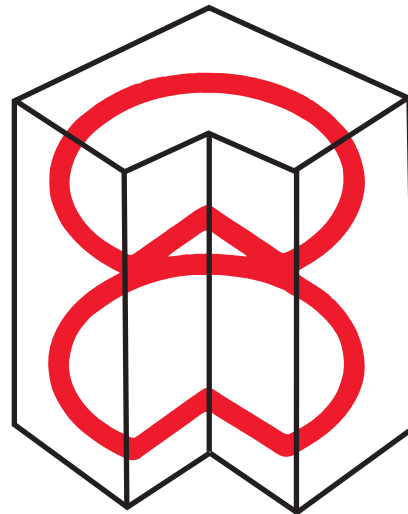

Form 4-94

Please keep this brochure
for future reference

INSUFFICIENT SIDE CLEARANCE ADJUSTMENT

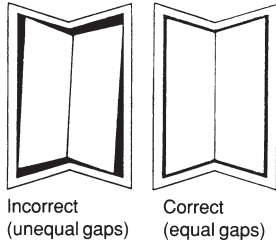

Step 1 Top Adjustment

Remove and save lockdown screws.

Loosen star washer screws to re-center pivot.

Tighten, check and repeat if necessary.

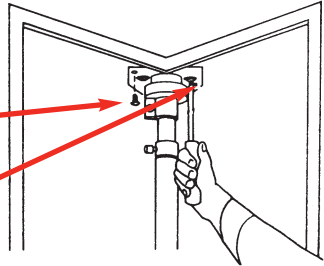

Step 2 Bottom Adjustment

Rotate door to expose screws on bottom bracket

Remove and save lock down screws.

Loosen star washer screws to re-center pivot cam base (both sides). Tighten, check and repeat if necessary.

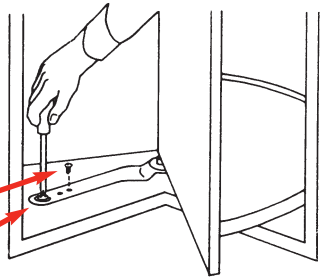

UNEVEN OR INCOMPLETE DOOR CLOSING ADJUSTMENT

(To center the doors correctly in the frame for proper clearance)

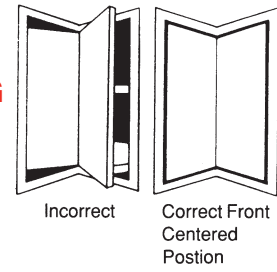

Step 1

Loosen clamp screw in white plastic housing (approx. 1 turn) to prepare for positioning adjustment.

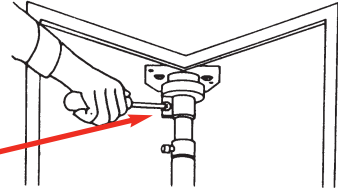

Step 2

Rotate door counter-clockwise until white plastic housing has been latched into position with spring. A resistance to turning will be felt when the housing reaches the latched position and may be accompanied at a click or latching sound.

Step 3

Rotate door slowly clockwise to exact front centered position but not pass it. Release door to check alignment. You may need to rotate door a little past center to allow for slight spring-back. If you rotate too far, go back to step 2 and repeat.

Step 4

SLOWLY rotate door counter-clockwise far enough so that clamp screw faces you again. Tighten clamp screw securely, being careful not to rotate white plastic housing out of position.

TOP/BOTTOM CLEARANCE ADJUSTMENT

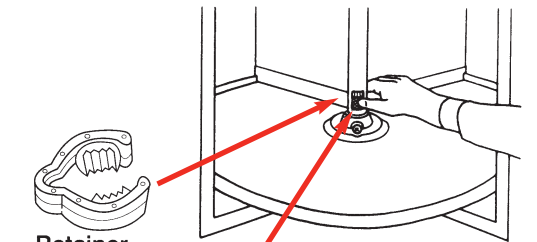
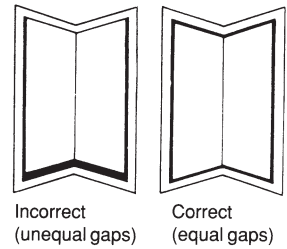

Step 1

Remove polymer retainer clip.

Step 2

Turn adjustment wheel (located inside cut out portion of shaft) clockwise to raise shelf/door unit. One full turn raises door 1/32". After adjustment, be sure to replace retainer clip.

Note: If shelves are heavily loaded, lift lower shelf slightly to aid adjustment. Total adjustment 1/2".

Note: When adjustments are completed, be sure to securely tighten all adjustment screws in housing, shaft bushing and tray adjustment screws. If bracket lock down screws were removed, please re-install after all adjustments are made.

Tools required for adjustments:
Phillips Screwdriver